

7.901.103

7.901.103 15 7.901.103 18 7.901.103 20 7.901.103 25 7.901.103 30
 7.901.103 35 7.901.103 A 7.901.103 B 7.901.103 C 7.901.103 CH
 7.901.103 2H 7.901.103 3H 7.901.103 TG

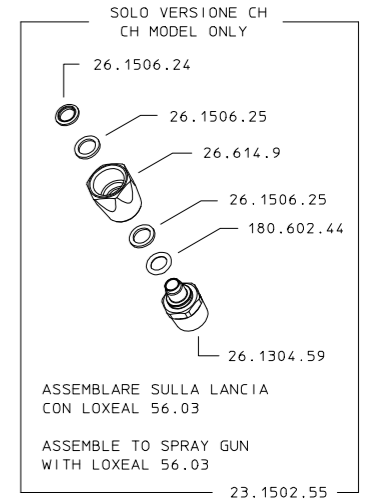
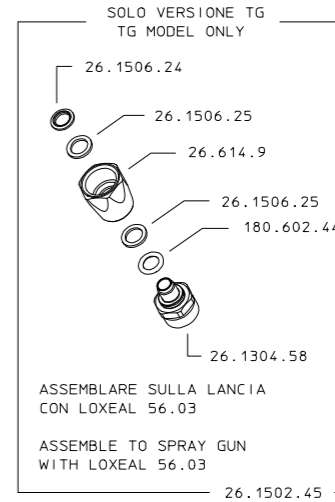
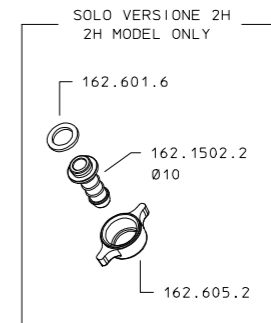
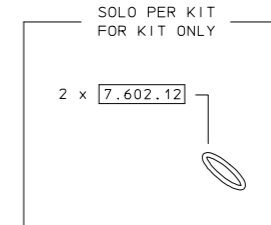
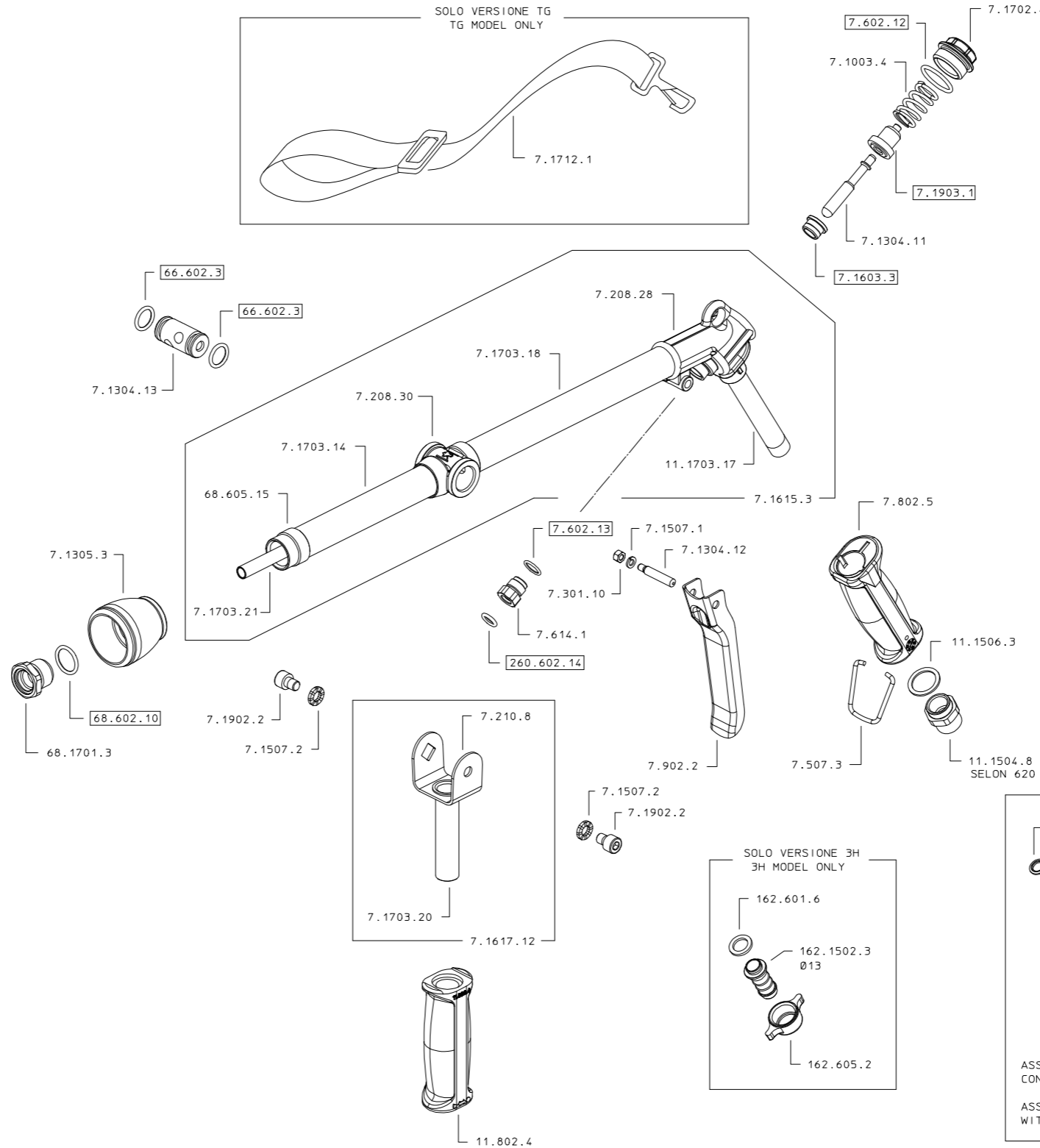
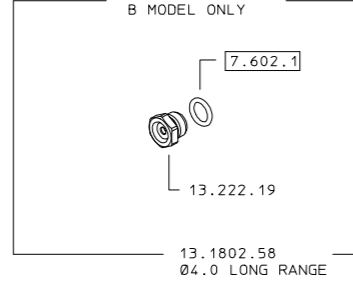
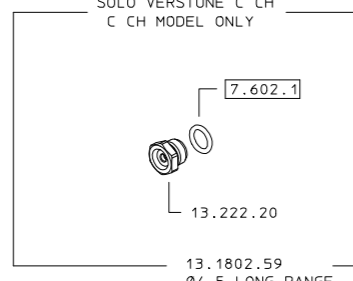
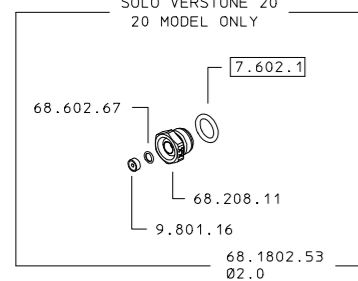
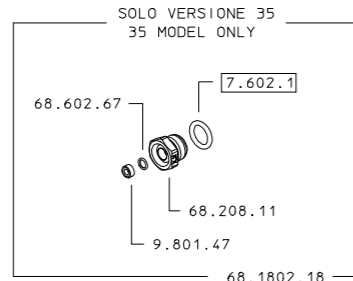
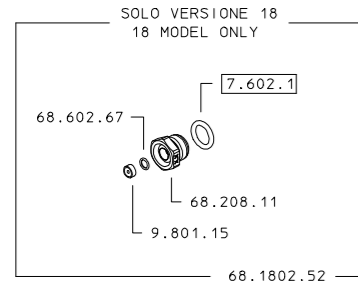
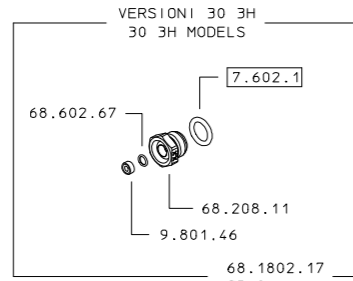
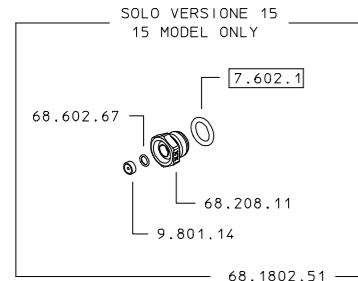
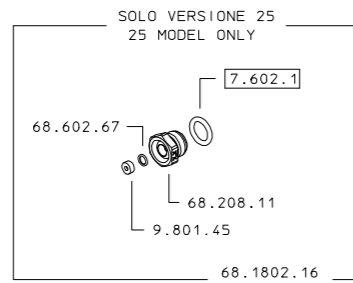
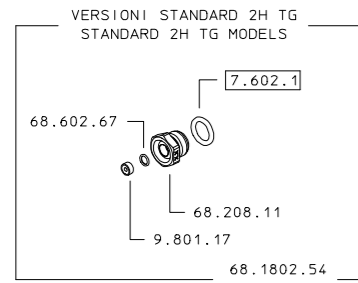

COME SI ORDINA / HOW TO ORDER
 Kit ricambio
 Spare parts kit **7.302.1**

DESCRIZIONE: LANCIA TURBINE 023	Tel. +39 0522 340648	DISGNATO	APPROVATO	Dis.N°/Codice	N°revisione	Data revisione
22022 REGGIO EMILIA - ITALY - LE E-mail: tecnico@braglia.it	Fax. +39 0522 345025	GBRAGLIA	GBRAGLIA	7.901.103	06	04/05/2012