

# 79.617.3

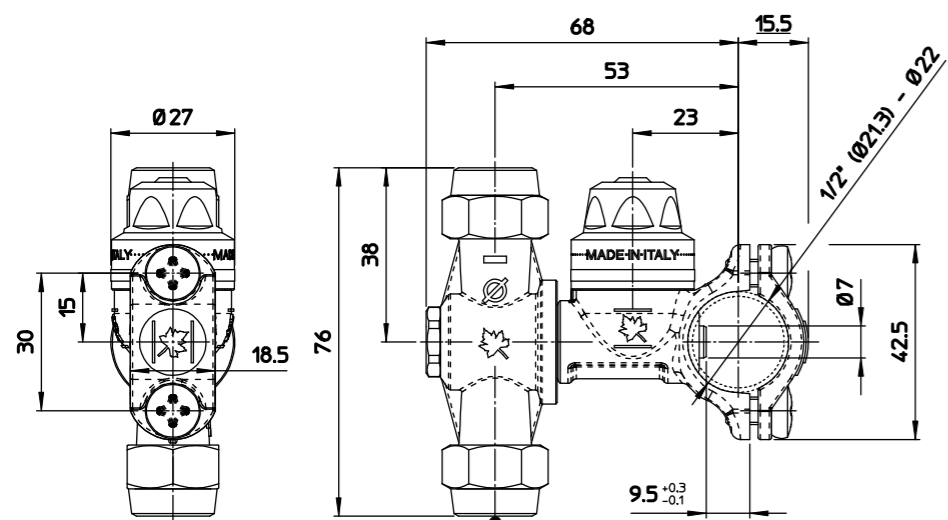

APERTO  
SPRAY POSITION

SCALA/SCALE 1:1

79.1902.44  
LOXEAL 56-03  
3-4 Nm

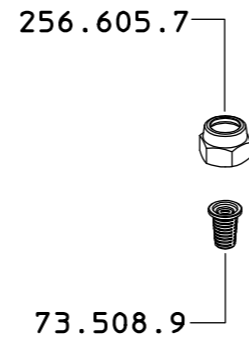

73.507.1  
35-40 cNm

73.507.1  
35-40 cNm

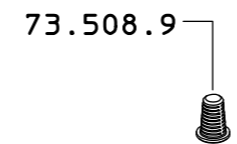

256.605.7

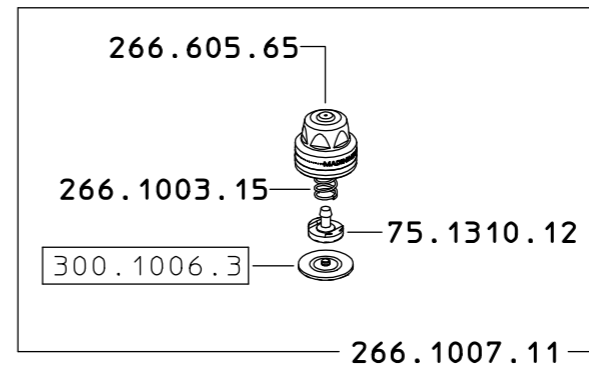

75.602.40

75.1706.4

73.602.22

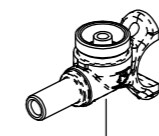

79.208.162

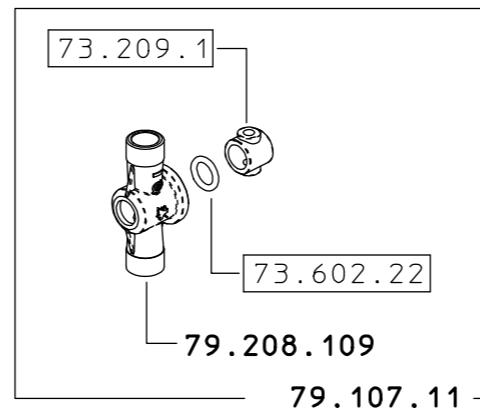
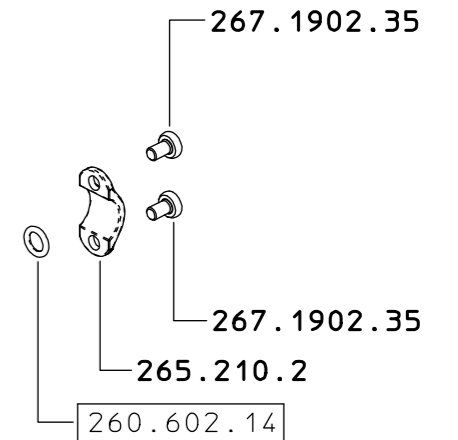

CONSULTARE LE DESCRIZIONI SUPPLEMENTARI  
DELLE FASI NEL CICLO DI LAVORAZIONE

ASSEMBLARE I COMPONENTI NEL RIQUADRO  
CONFEZIONARE N°10 PCS. CON:

- N°10 260.602.14
- N°10 265.210.2
- N°20 267.1902.35
- N°20 256.605.7
- N°20 73.508.9

SOLO PER KIT  
FOR KIT ONLY

- 2 x 23.602.34
- 68.602.10
- 3 x 73.602.22
- 260.602.14
- 75.1902.24
- 75.507.9
- 75.1003.23

COME SI ORDINA/HOW TO ORDER  
Kit ricambio  
Spare parts kit **75.302.28**