

125.503.1

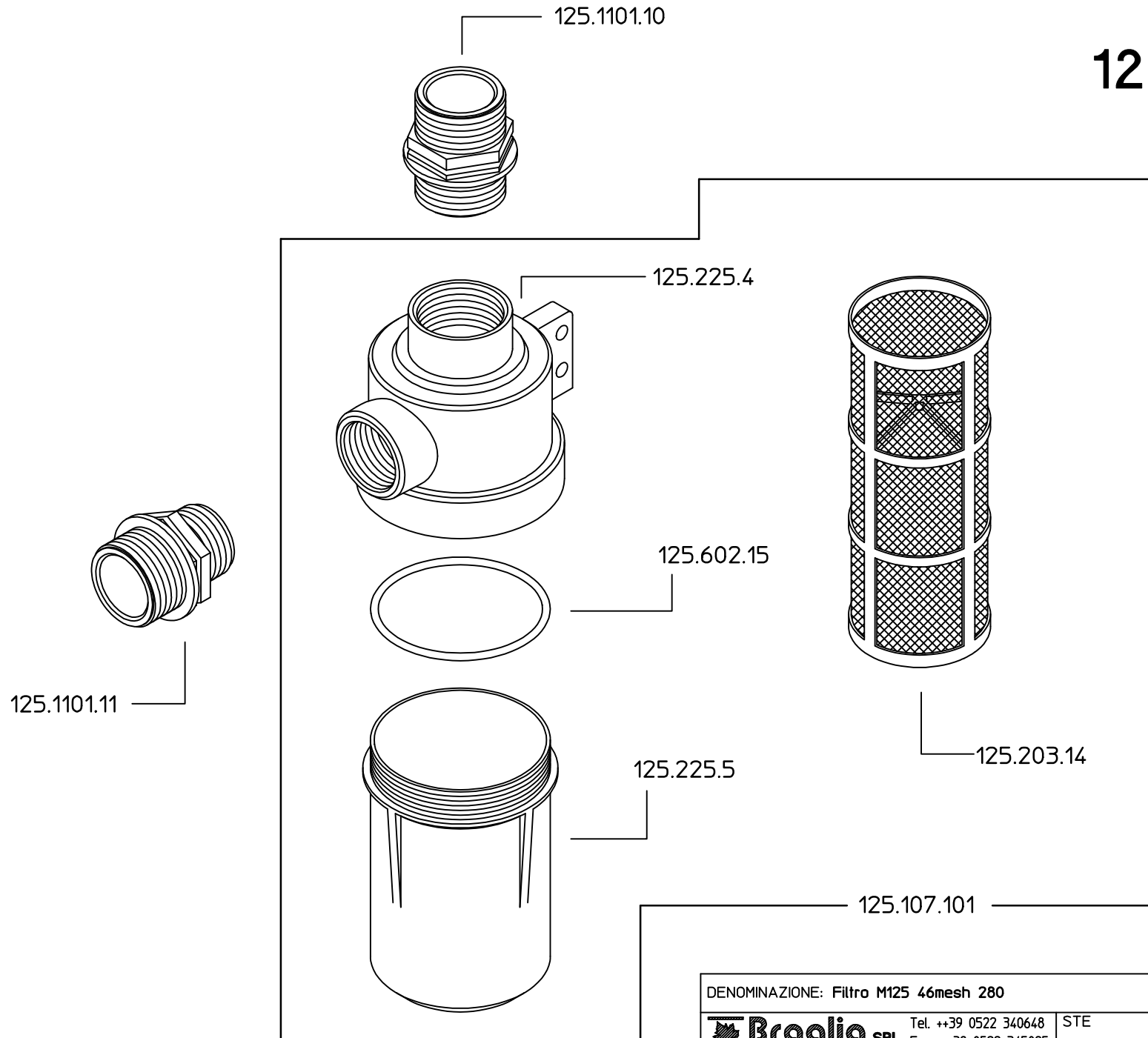

DENOMINAZIONE: Filtro M125 46mesh 280				N°revisione 01	Data revisione: 14/10/05
 Braglia SRL	Tel. ++39 0522 340648 Fax. ++39 0522 345025 Email braglia@braglia.it	STE	RTE	Dis.N°/Codice 125.503.1	
I-42029 Masone (REGGIO EMILIA)-ITALY-UE					