

180.302.42

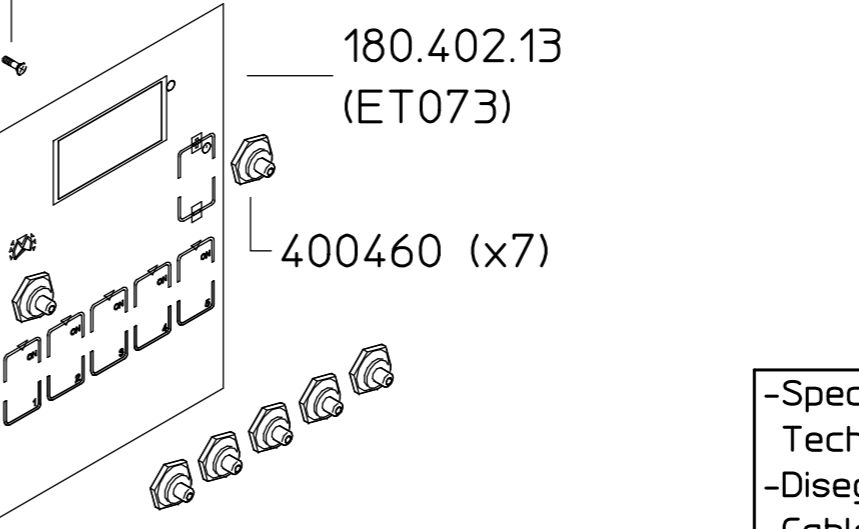
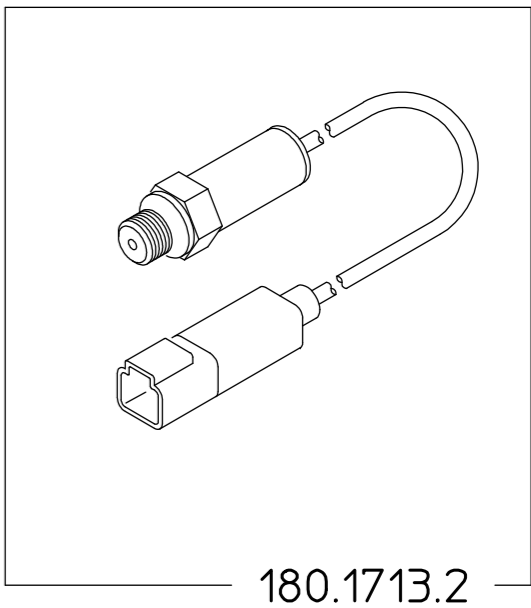
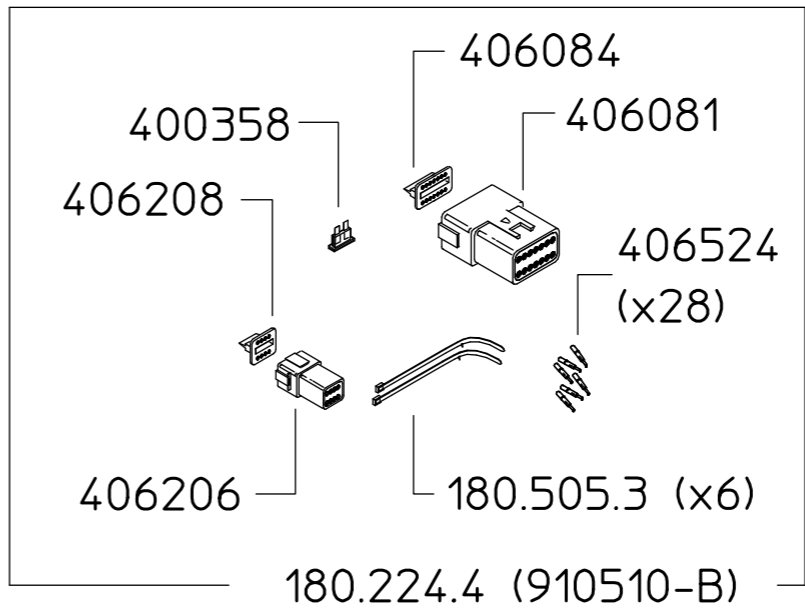
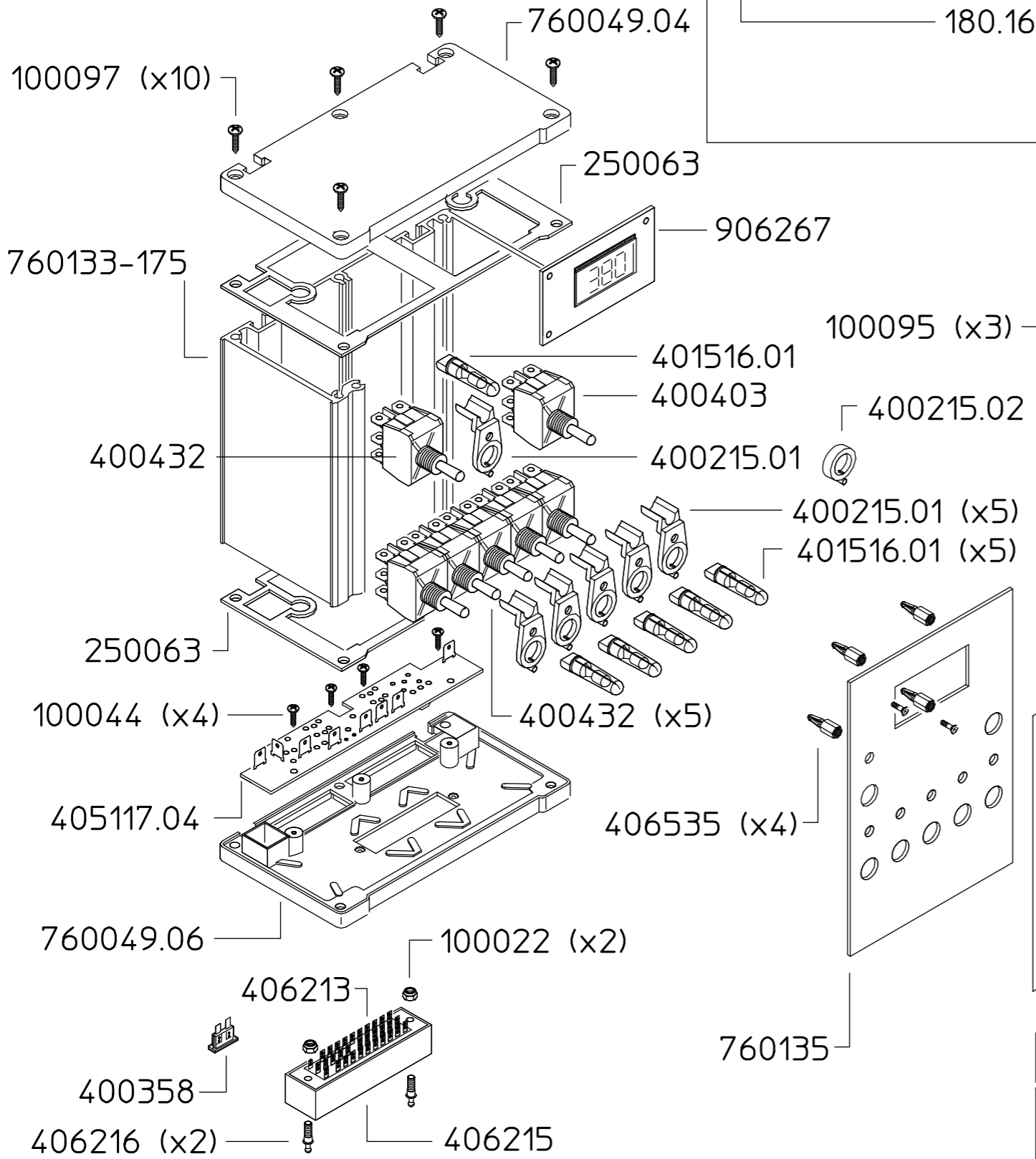
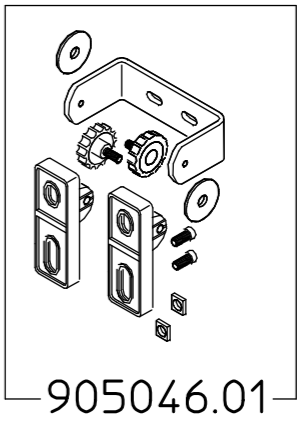
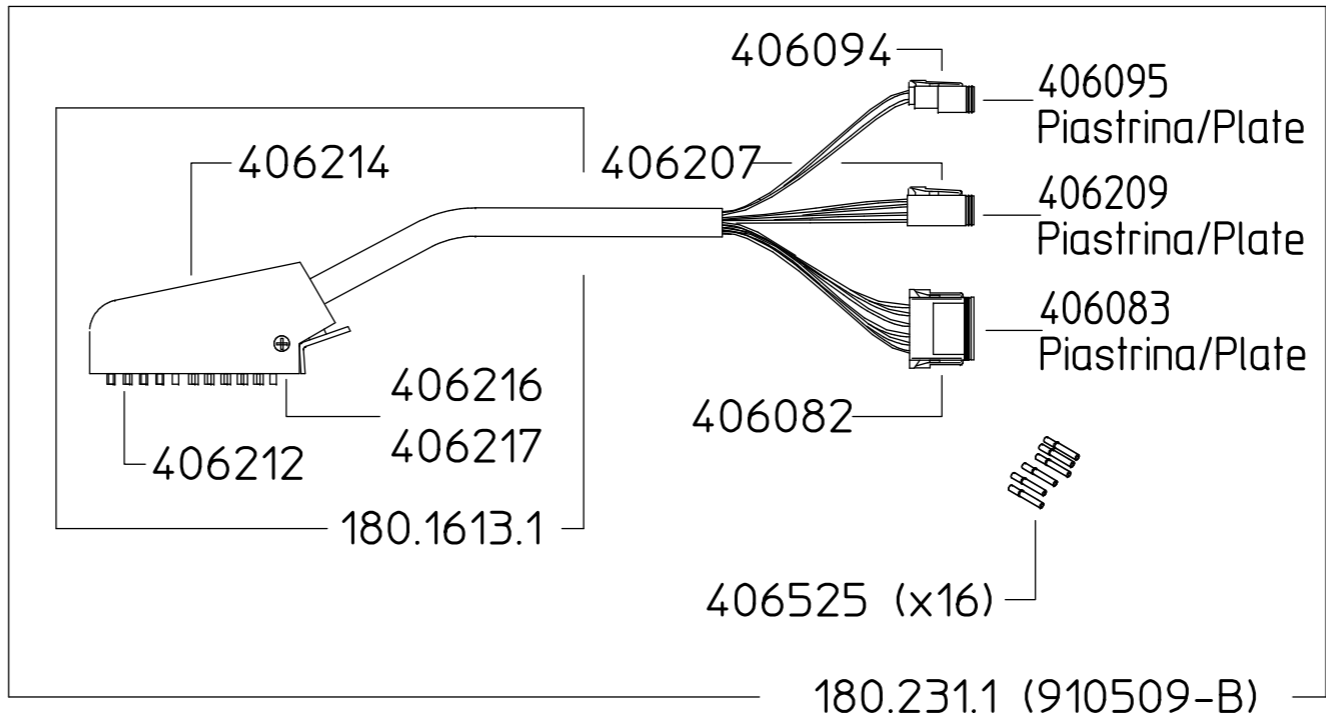
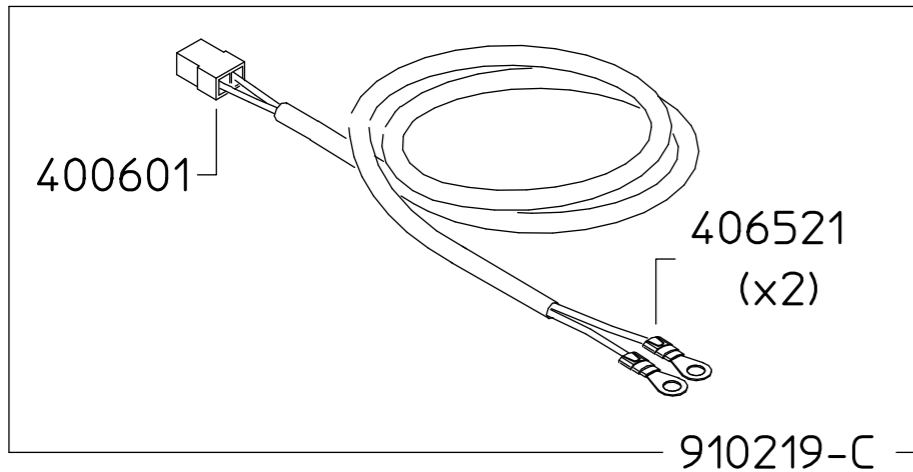

-Specifica tecnica di prodotto: 180.302.42
 Technical product specification
 -Disegno cablaggio cavo: 180.231.1.pdf
 Cable wiring drawing

DESCRIZIONE: KIT CONTROL 180 5+2 TRASDUTTORE		N°revisione 05	Data revisione 02/05/2016
Braglia SRL I-42122 REGGIO EMILIA - ITALY - UE Email tecnico@braglia.it	Tel. +39 0522 340648 Fax. +39 0522 345025	DISEGNATO G.BRAGLIA	APPROVATO G.BRAGLIA
	Dis.N°/Codice 180.302.42		