

# 73.617.39 A/B/C

Variante A / A Option

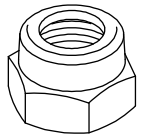

2 x 73.605.68

Variante B / B Option



2x 73.605.28

Variante C / C Option



73.605.28

73.508.9



2x 73.815.7

Variante standard / Standard option

73.605.68

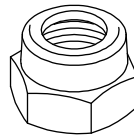

73.508.9

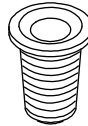

73.815.8

73.507.1



**Sigillafiletta**

75.1902.24

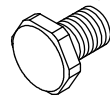

73.507.1

73.208.62

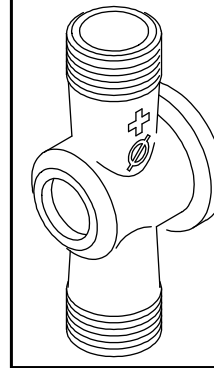

73.107.12

73.209.1

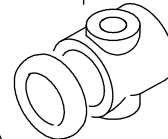

73.602.22

75.208.146

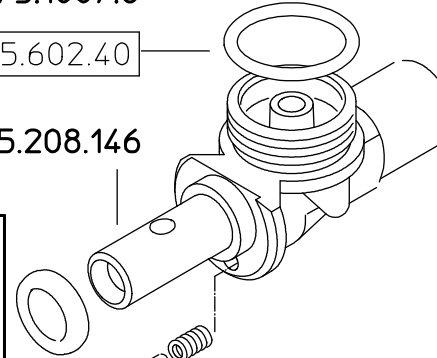

73.602.22

75.1003.23

75.507.9

73.107.44

75.605.61

266.1003.15

75.1310.12

300.1006.3

75.1007.8

75.602.40

Solo per kit  
Only for kit



23.602.34 X2

68.602.10

73.602.22 X3

260.602.14 X2

Variante standard / Standard option

73.508.9

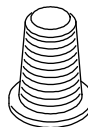

73.605.68

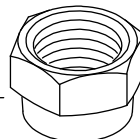

73.815.8

Come si ordina/How to order  
Kit ricambio-Cod. **75.302.28**  
Spare parts kit-C/N.

DENOMINAZIONE: <b>Getto M73 antigoccia 11/16 16UN 1/4"NPTF.</b>		N°revisione <b>02</b>	Data revisione: <b>22/02/10</b>
<b>Braglia</b> SRL I-42029 Masone (REGGIO EMILIA)-ITALY-UE	Tel. ++39 0522 340648	STE	RTE
	Fax. ++39 0522 345025	Dis.N°/Codice <b>73.617.39</b>	
Email <a href="mailto:braglia@braglia.it">braglia@braglia.it</a>			